

RUO

Universal plug Ø6, Ø8 with eye-bolt



100% nylon

Description

Universal plug with eye-bolt

Type of installation pre-fastening installation

Substrate concrete, solid clay brick, perforated solid brick, plasterboard

Sleeve material/protective coating

100%
nylon

Blue
zinc

Features and advantages of the product



Anti-rotation lugs

Protrusions on the sleeve keep it in place when screwing in the screw.



Stop collar

Screw hooks come with special stop collar which makes the screw rest on the plug and enables correct installation.

Nylon sleeve

Nylon with increased elasticity ensures correct expansion in the hollow material.



Installation

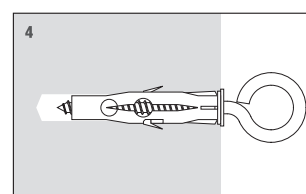
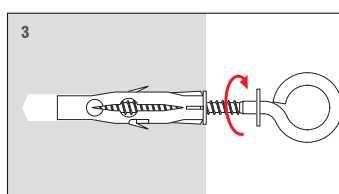
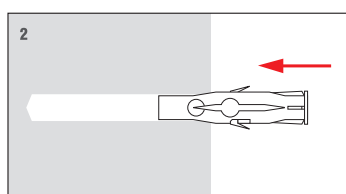
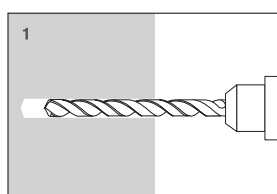

TECHNICAL DATA

Product marking

RU0	06	064
Type	Diameter	Length

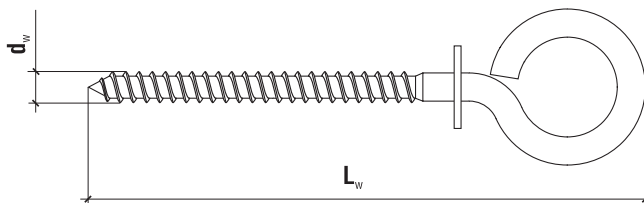
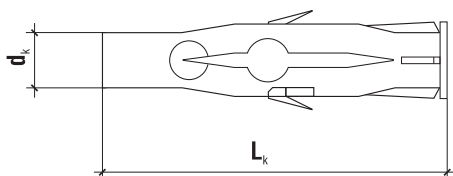

	Code	$d_k \times L_k$ [mm]	$d_w \times L_w$ [mm]	Pcs
ø6	RU0-06064	6.0 x 35	3.5 x 64	50
ø8	RU0-08084	8.0 x 50	4.5 x 84	25

TECHNICAL DATA

Parameter	Unit	RU0
Plug diameter	d_k [mm]	6/8
Hole diameter	d_o [mm]	6/8
Effective anchorage depth	h_{eff} [mm]	35/50*
Depth of drill hole	h_o [mm]	45/60*
Sleeve material	x	PA
Screw material	x	Zinc plated steel

* - for RU0-8

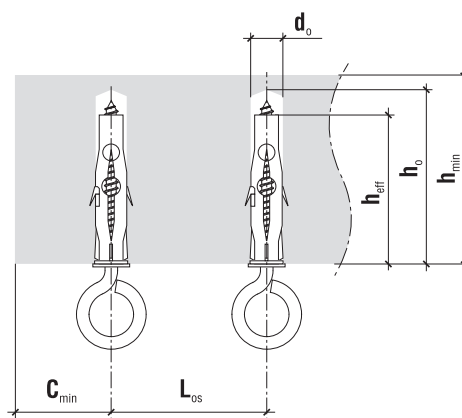

DESIGN PULL-OUT RESISTANCE [kN]

Substrate	RU0-6	RU0-8
Concrete C20/25	0.20	0.28
Solid clay brick	0.14	0.20
Perforated solid brick	0.14	0.20
Plasterboard	0.18	0.26

* - min. plasterboard thickness 6 mm for each type of fastener

SUBSTRATE, MINIMUM THICKNESS, DISTANCE

Plug type	Min. member thickness h_{min} [mm]	Min. edge distance c_{min} [mm]	Min. spacing L_{os} [mm]
RU0-6	70	70	140
RU0-8	100	100	200